

1. WIRING DIAGRAMS

Screw terminals, overview

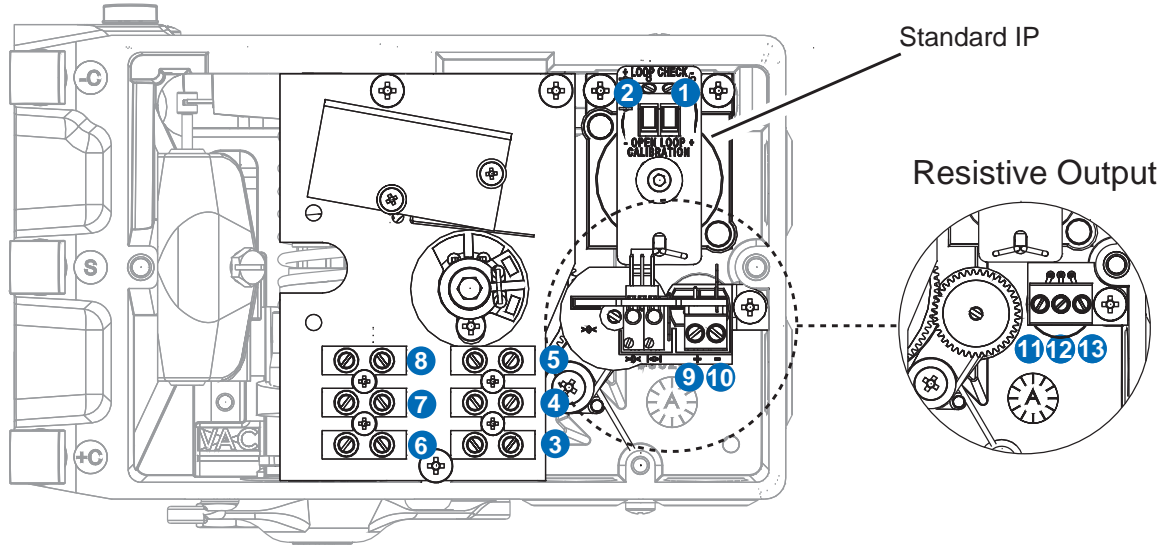

Terminal assignment

Standard IP Transducer

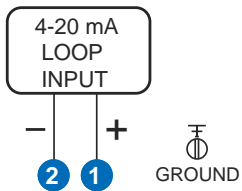

Loop Input
4 - 20 mA

Position Feedback

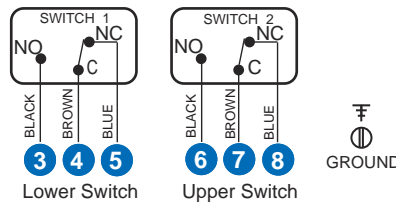

2 SPDT Mechanical Switches
Camden CSM30520D

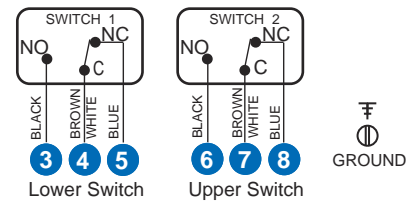

2 SPDT Magnetic sensors
Hamlin Reed 9145

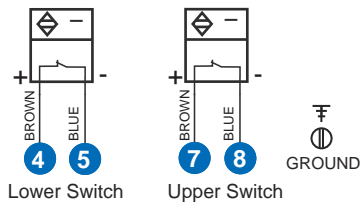
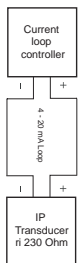

2 Inductive Sensors NAMUR
P+F NJ2-V3-N

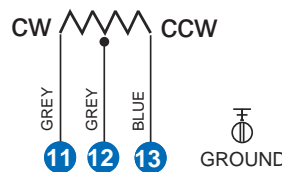

Resistive Output
0 - 10K ohm
0 - 1K ohm

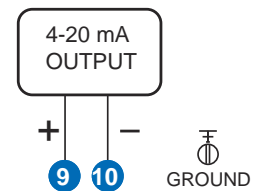

Current Output

